

MATTEN	MAAS	LENGTE	BREEDTE	GEWICHT	N.W.M. M ^{1/2}	N.W.G. M ^{1/2}	V.P.E.	OVERPRIJS
BEC-188-A	6-150	5950	2350	36,48	10,82	3,38	40	0,015
BEC-257-A	7-150	5950	2350	49,62	10,82	4,59	30	0,005
BEC-335-A	8-150	4450	2350	45,23	7,02	6,45	30	basis
BEC-424-A	9-150	6000	2400	79,04	9,72	8,14	20	basis
BEC-503-A	8-100	3500	2200	49,57	5,10	9,72	30	0,010
BEC-524-A	10-150	5900	2300	89,71	8,66	10,36	15	basis
BEC-785-A	10-100	6000	2400	141,42	9,01	15,70	10	0,010
B335A	8-150	5950	2350	64,90	10,82	5,60	20	basis

EWAKO Wapeningscentrale

De Bonkelaar 9

3774 SB Kootwijkerbroek

T. 0342 44 2377

E. info@ewako.nl



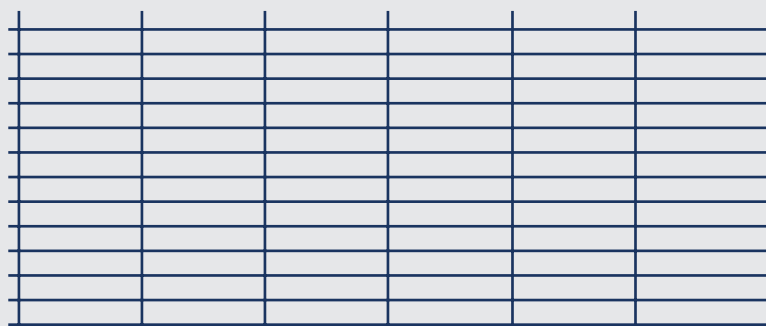

MATTEN	MAAS	LENGTE	BREEDTE	GEWICHT	N.W.M. M ^{1/2}	N.W.G. M ^{1/2}	V.P.E.	OVERPRIJS
SM-636	9-100	6000	1150	38,66			25	0,06
SM-754	12-150	6000	1150	45,35			25	0,05
SM-830	12-100	6000	750	44,4			25	0,06

EWAKO Wapeningscentrale

De Bonkelaar 9

3774 SB Kootwijkerbroek

T. 0342 44 2377

E. info@ewako.nl



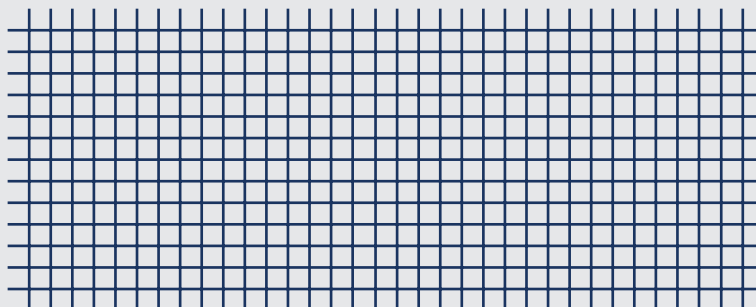

MATTEN	MAAS	LENGTE	BREEDTE	GEWICHT	N.W.M. M ^{1/2}	N.W.G. M ^{1/2}	V.P.E.	OVERPRIJS
P-188-A	6-150	5000	2000	29,08			50	0,015
P-335-A	8-150	5000	2000	51,75			30	basis
P-524-A	10-150	5000	2000	80,83			20	basis

EWAKO Wapeningscentrale

De Bonkelaar 9
3774 SB Kootwijkerbroek
T. 0342 44 2377
E. info@ewako.nl



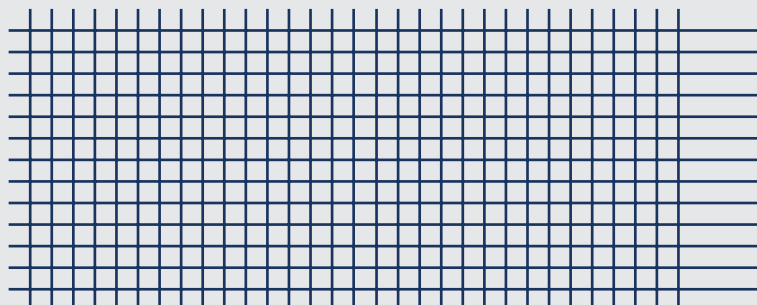

MATTEN	MAAS	LENGTE	BREEDTE	GEWICHT	N.W.M. M ^{1/2}	N.W.G. M ^{1/2}	V.P.E.	OVERPRIJS
F-188-A	6-150	5950	1950	33,62	5,55	6,06		0,090
FS-335-A	8-150	5050	1950	49,81	4,65	10,72		0,060
FH-335-A	8-150	2500	2350	29,55	1,95	15,16		0,060
FH-524-A	10-150	2500	2400	46,71	1,95	23,96		0,060

EWAKO Wapeningscentrale

De Bonkelaar 9

3774 SB Kootwijkerbroek

T. 0342 44 2377

E. info@ewako.nl



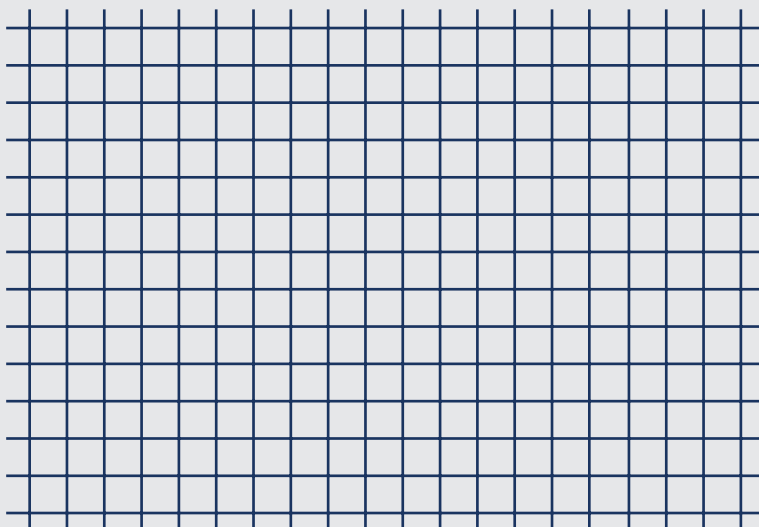

MATTEN	MAAS	LENGTE	BREEDTE	GEWICHT	N.W.M. M ^{1/2}	N.W.G. M ^{1/2}	V.P.E.	OVERPRIJS
PS-130-A	5-150	3000	2000	12,63			50	0,095
PS-196-A	5-100	3000	2000	18,48			50	0,105
PS-262-A	5-75	3000	2000	24,81			50	0,120
PS-188-A	6-150	3000	2000	18,2			50	0,025
PS-283-A	6-100	3000	2000	26,7			50	
PS-335-A	8-150	3000	2000	32,39			40	0,010
PS-524-A	10-150	3000	2000	50,59			40	

EWAKO Wapeningscentrale

De Bonkelaar 9

3774 SB Kootwijkerbroek

T. 0342 44 2377

E. info@ewako.nl



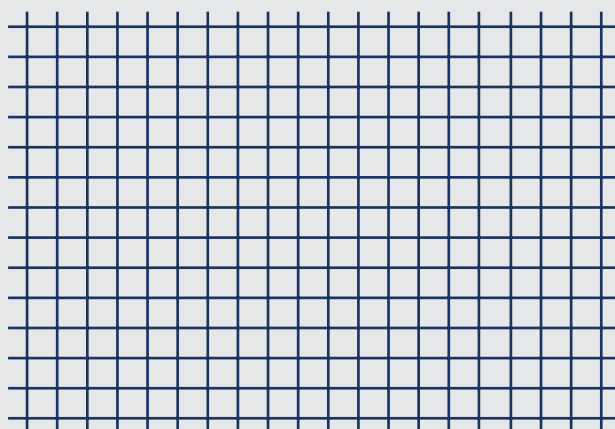

MATTEN	MAAS	LENGTE	BREEDTE	GEWICHT	N.W.M. M ^{1/2}	N.W.G. M ^{1/2}	V.P.E.	OVERPRIJS
QS130V	5-150	3000	2000	13,9			50	
QS188V	6-150	3000	2000	20,02			50	
QS196V	5-100	3000	2000	20,33			50	
QS262V	5-75	3000	2000	27,28				

EWAKO Wapeningscentrale

De Bonkelaar 9

3774 SB Kootwijkerbroek

T. 0342 44 2377

E. info@ewako.nl



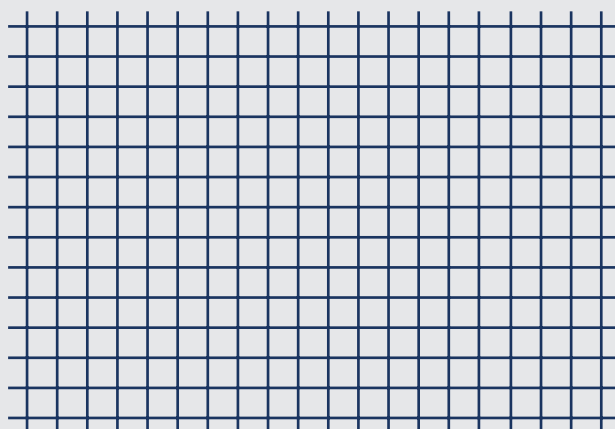

MATTEN	MAAS	LENGTE	BREEDTE	GEWICHT	N.W.M. M ^{1/2}	N.W.G. M ^{1/2}	V.P.E.	OVERPRIJS
GAASMAT	4-50	3000	2000	27				
GAASMAT*	4-50	3000	2000	27,32				
GAASMAT*	3-50	3600	2100					
GAASMAT*	3-25 / 3-75	2500	2000					

* Verzinkt

EWAKO Wapeningscentrale

De Bonkelaar 9

3774 SB Kootwijkerbroek

T. 0342 44 2377

E. info@ewako.nl



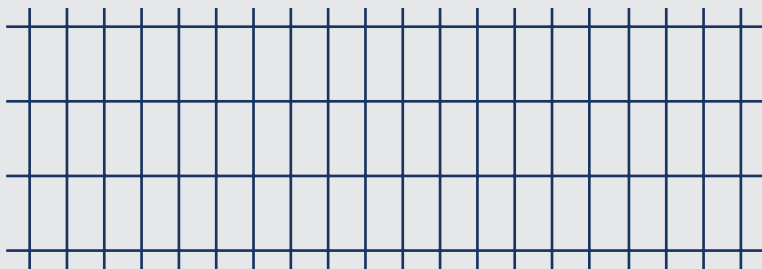

MATTEN	MAAS	LENGTE	BREEDTE	GEWICHT	N.W.M. M ^{1/2}	N.W.G. M ^{1/2}	V.P.E.	OVERPRIJS
E131	5-250 / 5-150	3500	875	5,39			100	
E196	5-250 / 5-100	3500	1125	8,76			100	
E283	5-250 / 6-100	3500	1375	13,92			100	

EWAKO Wapeningscentrale

De Bonkelaar 9

3774 SB Kootwijkerbroek

T. 0342 44 2377

E. info@ewako.nl



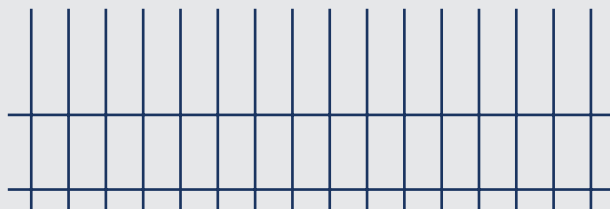

MATTEN	MAAS	LENGTE	BREEDTE	GEWICHT	N.W.M. M ^{1/2}	N.W.G. M ^{1/2}	V.P.E.	OVERPRIJS
S010	10-150 / 5-400	2600	1200	13,74	2,55	5,39	50	
S012	12-150 / 5-450	2600	1300	21,2	2,55	8,32	50	
S081	8-150 / 6-100	2600	1000	7,52	2,55	2,95	50	

EWAKO Wapeningscentrale

De Bonkelaar 9

3774 SB Kootwijkerbroek

T. 0342 44 2377

E. info@ewako.nl



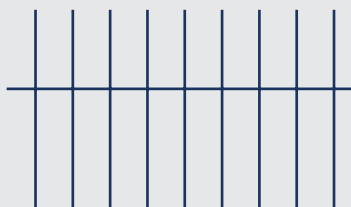

MATTEN	MAAS	LENGTE	BREEDTE	GEWICHT	N.W.M. M ^{1/2}	N.W.G. M ^{1/2}	V.P.E.	OVERPRIJS
V154	5-100 / 7-250	2250	1000	3,41	2,25	1,52	100	
V254	6-100 / 9-250	2250	1000	5,49	2,25	2,44	100	

EWAKO Wapeningscentrale

De Bonkelaar 9

3774 SB Kootwijkerbroek

T. 0342 44 2377

E. info@ewako.nl



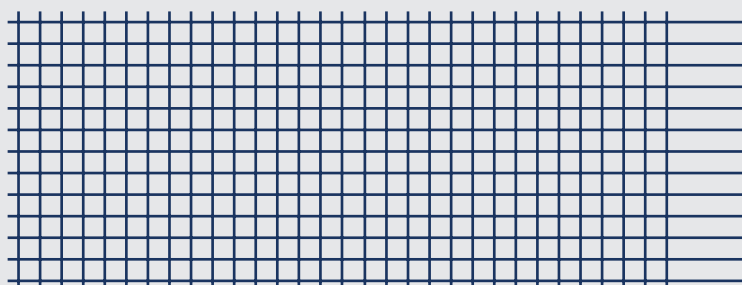

MATTEN	MAAS	LENGTE	BREEDTE	GEWICHT	N.W.M. M ^{1/2}	N.W.G. M ^{1/2}	V.P.E.	OVERPRIJS
ST52	8-150	3580	520	10	3,15	3,18	50	
ST62	8-150	3580	620	10,43	3,15	3,32	50	
ST72	8-150	3580	720	14,5	3,15	4,61	50	
ST82	8-150	3580	820	15,57	3,15	4,95	50	
ST92	8-150	3580	920	17,54	3,15	5,57	50	

EWAKO Wapeningscentrale

De Bonkelaar 9

3774 SB Kootwijkerbroek

T. 0342 44 2377

E. info@ewako.nl





MATTEN	MAAS	LENGTE	BREEDTE	GEWICHT	N.W.M. M ^{1/2}	N.W.G. M ^{1/2}	V.P.E.	OVERPRIJS
ST6535	8-150 / 110VO /	2000		7,11	2,1	3,39	48	

EWAKO Wapeningscentrale

De Bonkelaar 9

3774 SB Kootwijkerbroek

T. 0342 44 2377

E. info@ewako.nl



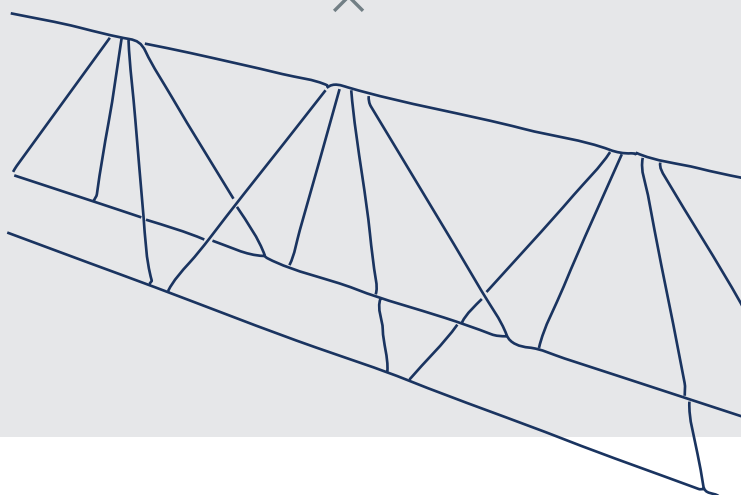

SUPPORTLIGGER	LENGTE	GEWICHT	V.P.E.
H050	2000	0,856	25/250
H060	2000	0,870	25/250
H070	2000	0,886	25/250
H080	2000	0,904	25/250
H090	2000	0,922	25/250
H100	2000	0,942	25/250
H110	2000	0,964	25/250
H120	2000	0,984	25/250
H130	2000	1,006	25/250
H140	2000	1,028	25/250
H150	2000	1,052	25/250
H160	2000	1,074	25/250
H170	2000	1,098	25/250
H180	2000	1,122	25/250
H190	2000	1,146	25/250
H200	2000	1,170	25/250
H230	2000	1,574	20/100
H250	2000	1,648	20/100
H280	2000	2,578	20/100
H300	2000	2,696	20/100

EWAKO Wapeningscentrale

De Bonkelaar 9

3774 SB Kootwijkerbroek

T. 0342 44 2377

E. info@ewako.nl





DRAAD	LENGTE	GEWICHT
Ø 8	OP ROL	0,402
Ø 10	OP ROL	0,628
Ø 12	OP ROL	0,905
Ø 16	OP ROL	1,610
Ø 12	12 mt	0,905
Ø 16	12 & 14 mt	1,610
Ø 20	12 & 14 mt	2,510
Ø 25	12 & 14 mt	3,930
Ø 32	12 & 14 mt	6,430
Ø 40	14 mt	10,001
Ø 50	14 mt	15,413



EWAKO Wapeningscentrale

De Bonkelaar 9

3774 SB Kootwijkerbroek

T. 0342 44 2377

E. info@ewako.nl



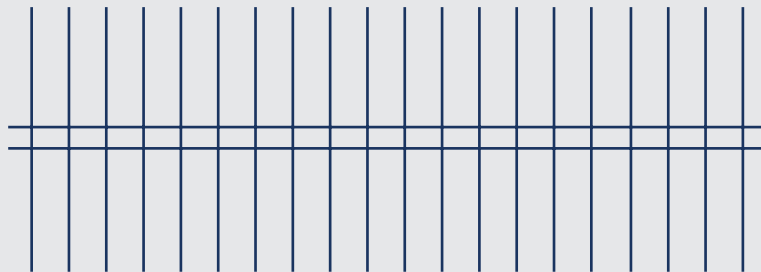

MATTEN	MAAS	LENGTE	BREEDTE	GEWICHT	N.W.M. M ^{1/2}	N.W.G. M ^{1/2}	V.P.E.	OVERPRIJS
V189	5-100 / 6-150	2500	1300	5,68			100	
V257	5-100 / 7-150	2500	1500	8,47			50	
V50	5-225 / 5-250	2500	450	1,46			50	

EWAKO Wapeningscentrale

De Bonkelaar 9

3774 SB Kootwijkerbroek

T. 0342 44 2377

E. info@ewako.nl





MATTEN	MAAS	LENGTE	BREEDTE	GEWICHT	N.W.M. M ^{1/2}	N.W.G. M ^{1/2}	V.P.E.	OVERPRIJS
F257	7-150	5950	1950	45,74	5,55	8,25	30	0,240

EWAKO Wapeningscentrale

De Bonkelaar 9
3774 SB Kootwijkerbroek
T. 0342 44 2377
E. info@ewako.nl



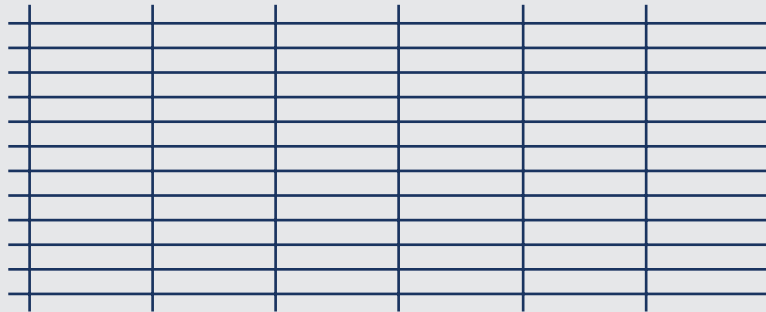

MATTEN	MAAS	LENGTE	BREEDTE	GEWICHT	N.W.M. M ^{1/2}	N.W.G. M ^{1/2}	V.P.E.	OVERPRIJS
SM-424	9-150	5800	1850	40,98			30	
SM-503	8-100	5800	1850	47,91			25	
SM-524	10-150	5800	1850	49,88			25	
SM-785	10-100	6000	1150	47,15			25	

EWAKO Wapeningscentrale

De Bonkelaar 9
3774 SB Kootwijkerbroek
T. 0342 44 2377
E. info@ewako.nl

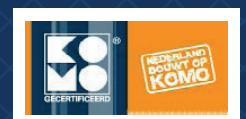

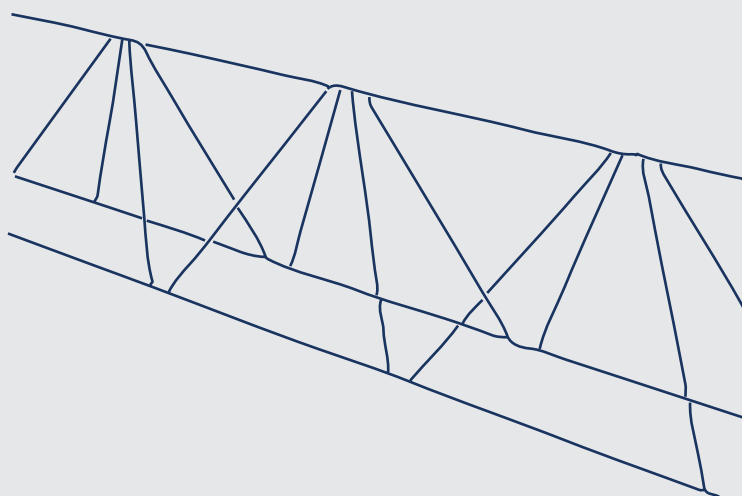

SUPPORTLIGGER	MAAS	LENGTE	V.P.E.
H050	210 t/m 300 *	2000	100
H060	320 t/m 400 **	2000	50

* Per 1 cm oplopend

** Per 2cm oplopend

EWAKO Wapeningscentrale

De Bonkelaar 9

3774 SB Kootwijkerbroek

T. 0342 44 2377

E. info@ewako.nl

